











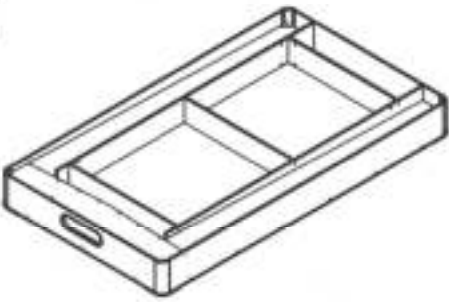
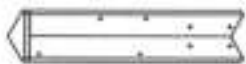

# POOL TABLE SIRIO 7FT

# INSTRUCTIONS









---



# PARTS IDENTIFIER

|   |  |  |
|---|--|--|
| <p><b>P1</b></p>  <p>Pool table 1set</p>               | <p><b>P2</b></p>  <p>Leg A 2 pcs</p>               |  |
|   |  | <p><b>P3</b></p>  <p>Leg B 2 pcs</p>           |
| <p><b>P3</b></p>  <p>Leg side panel<br/>2 pcs</p>      | <p><b>P5</b></p>  <p>Leg end panel<br/>2 pcs</p>    | <p><b>P6</b></p>  <p>Leg leveler<br/>4 pcs</p>  |
| <p><b>P7</b></p>  <p>Table tennis surface<br/>1 pc</p> |  |  |
| <p><b>#1</b></p>  <p>5/16" Bolt<br/>16 pcs</p>       | <p><b>#2</b></p>  <p>5/16" Washer<br/>16 pcs</p>  | <p><b>#3</b></p>  <p>1/4" Bolt<br/>16 pcs</p> |
| <p><b>#4</b></p>  <p>1/4" Washer<br/>32 pcs</p>      | <p><b>#5</b></p>  <p>1/4" Lock nut<br/>16 pcs</p> | <p><b>#6</b></p>  <p>Tool<br/>1 pc</p>        |

# PARTS IDENTIFIER

|  |   |  |
|--|---|--|
| <p><b>#7</b></p>  <p>Tool<br/>1 pc</p>              |   |  |
| <p><b>A1</b></p>  <p>Billiard ball<br/>1set</p>     | <p><b>A2</b></p>  <p>Chalk<br/>2 pcs</p>           | <p><b>A3</b></p>  <p>Cue stick<br/>2pcs</p>          |
| <p><b>A4</b></p>  <p>Brush<br/>1 pc</p>             | <p><b>A5</b></p>  <p>Triangle rack<br/>1 pc</p>    | <p><b>A6</b></p>  <p>Table tennis paddle<br/>2pcs</p> |
| <p><b>A7</b></p>  <p>Table tennis ball<br/>3pcs</p> | <p><b>A8</b></p>  <p>Table tennis net<br/>1set</p> |  |

# ASSEMBLY INSTRUCTIONS

WARNING: TWO ADULTS NEEDED ASSEMBLE POOL TABLE

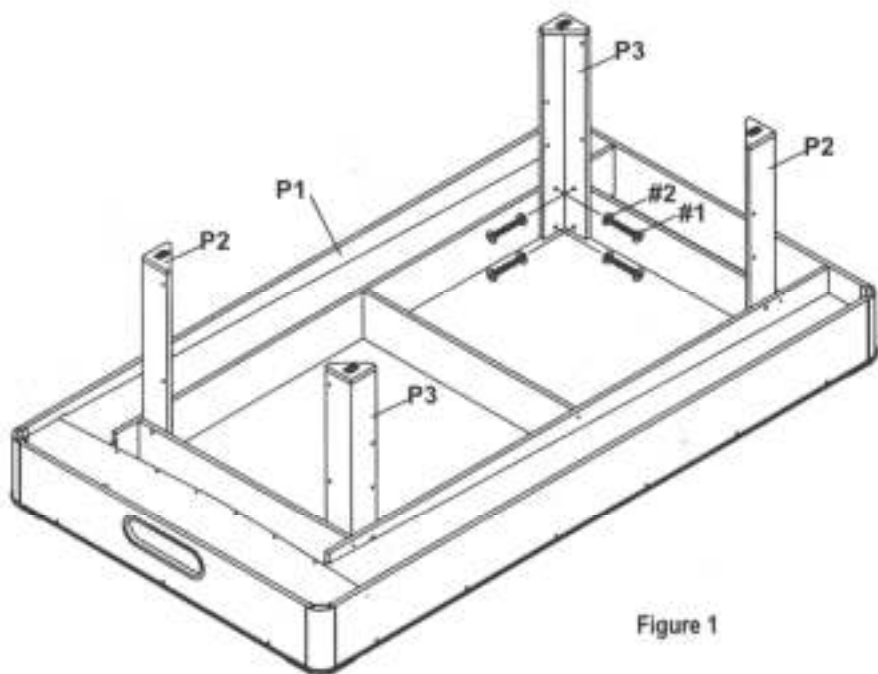

Figure 1

# ASSEMBLY INSTRUCTIONS

WARNING: TWO ADULTS NEEDED ASSEMBLE POOL TABLE

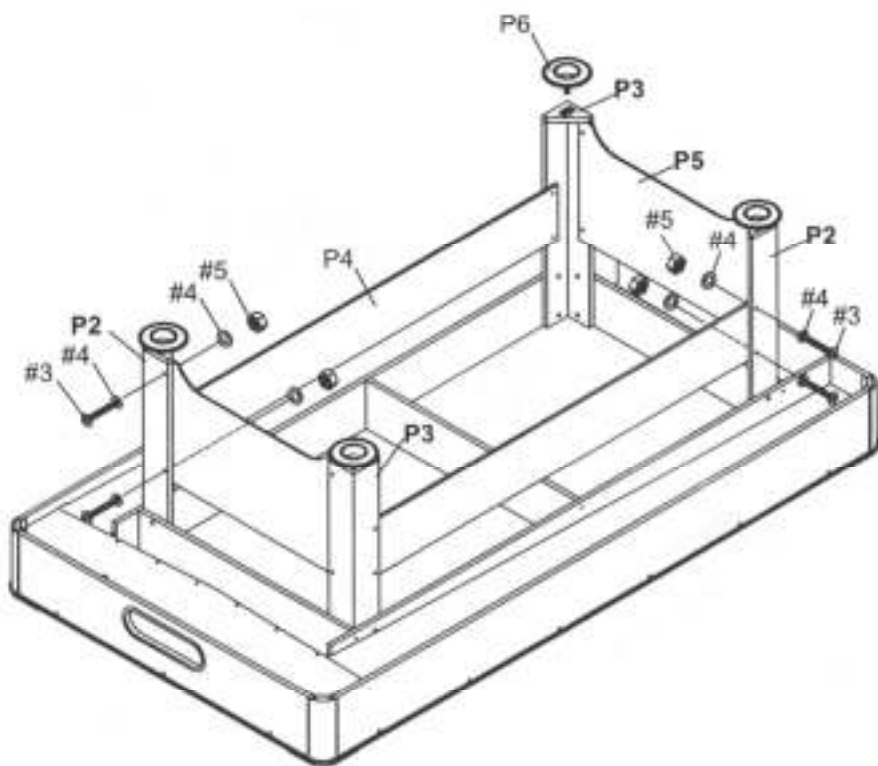

Figure 2

# ASSEMBLY INSTRUCTIONS

WARNING: TWO ADULTS NEEDED ASSEMBLE POOL TABLE

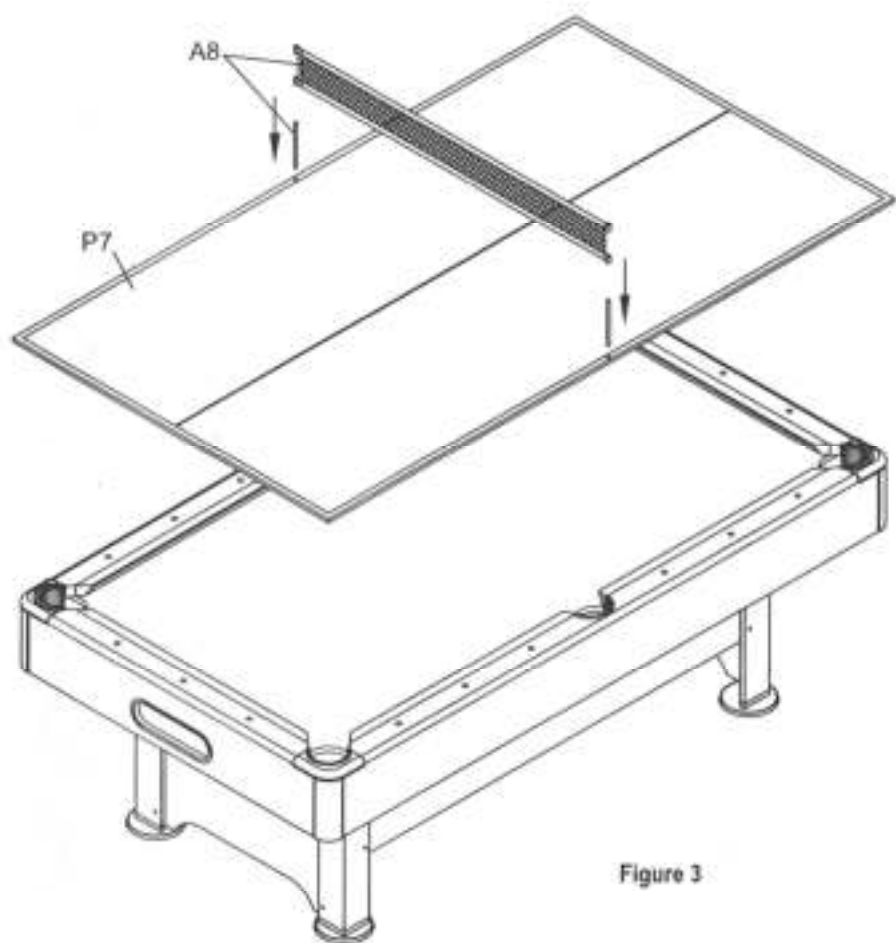

Figure 3